

This article was downloaded by:

On: 25 January 2011

Access details: *Access Details: Free Access*

Publisher *Taylor & Francis*

Informa Ltd Registered in England and Wales Registered Number: 1072954 Registered office: Mortimer House, 37-41 Mortimer Street, London W1T 3JH, UK



## Liquid Crystals

Publication details, including instructions for authors and subscription information:

<http://www.informaworld.com/smpp/title~content=t713926090>

### Optimization of film-compensated homogeneous cells for liquid crystal displays

Shin-Tson Wu; Chiung-Sheng Wu

Online publication date: 06 August 2010

**To cite this Article** Wu, Shin-Tson and Wu, Chiung-Sheng(1998) 'Optimization of film-compensated homogeneous cells for liquid crystal displays', *Liquid Crystals*, 24: 6, 811 – 818

**To link to this Article:** DOI: 10.1080/026782998206623

**URL:** <http://dx.doi.org/10.1080/026782998206623>

PLEASE SCROLL DOWN FOR ARTICLE

Full terms and conditions of use: <http://www.informaworld.com/terms-and-conditions-of-access.pdf>

This article may be used for research, teaching and private study purposes. Any substantial or systematic reproduction, re-distribution, re-selling, loan or sub-licensing, systematic supply or distribution in any form to anyone is expressly forbidden.

The publisher does not give any warranty express or implied or make any representation that the contents will be complete or accurate or up to date. The accuracy of any instructions, formulae and drug doses should be independently verified with primary sources. The publisher shall not be liable for any loss, actions, claims, proceedings, demand or costs or damages whatsoever or howsoever caused arising directly or indirectly in connection with or arising out of the use of this material.

# Optimization of film-compensated homogeneous cells for liquid crystal displays

by SHIN-TSON WU\* and CHIUNG-SHENG WU

HRL Laboratories (previously Hughes Research Laboratories),  
3011 Malibu Canyon Road, Malibu, California 90265, USA

(Received 14 November 1997; accepted 2 December 1997)

Computer simulations on the display characteristics of polymeric-film-compensated homogeneous liquid crystal cells were performed. Both transmissive and reflective displays were investigated. Results indicate that the biaxial film-compensated reflective displays exhibit small wavelength dispersion, wide viewing angle, high contrast ratio and short response time. Their potential applications in reflective-type colour-sequential projection and direct-view displays are emphasized.

## 1. Introduction

A film-compensated homogeneous (also known as parallel-aligned) liquid crystal (LC) cell has been demonstrated to possess a short (less than 5 ms) response time, which is attractive for colour-sequential projection displays [1, 2]. However, due to its limited viewing angle, such a device is seldom considered for use in direct-view displays. A general approach for widening the viewing angle is to reduce the  $d\Delta n$  of the LC layer [3, 4]; here  $d$  represents the cell gap and  $\Delta n$  the LC birefringence. Another approach is to use the optically compensated-bend (OCB) cell [5, 6]. Unlike in a parallel cell, the pretilt angles in the front and rear substrates of a bend cell are in the opposite direction, i.e. anti-parallel. Benefiting from these opposing pretilt angles, the OCB cell exhibits a wide and nearly symmetric viewing angle. A problem of the OCB cell is the need for a constant bias voltage ( $\sim 2 V_{\text{rms}}$ ) in order to overcome domain instability [6]. Moreover, the uniformity of this bias voltage over the entire display area greatly affects the contrast ratio.

Generally speaking, a reflective display has an inherently wider viewing angle than a transmissive cell. In a reflective display, the incident and reflected light beams see the opposite tilt of the LC directors [7]. As a result, its viewing angle is equivalent to that observed in a two-domain transmissive cell [8]. For a reflective homogeneous cell, if its  $d\Delta n$  is close to the first-order half-wave plate, then its viewing angle is quite wide, giving it potential for direct-view displays [9].

In this article we report computer simulation results on the electro-optic effects and viewing angle charac-

teristics of film-compensated homogeneous cells. Both transmissive and reflective displays are analysed. In each type of display, both normally white and normally black modes can be obtained by selecting the  $d\Delta n$  value of the compensated film employed. In §2 we briefly review the phase compensation principle and point out the desirable features of a phase-matched compensation film. In §3 we present the computer simulation results of transmissive displays. In §4 we extend similar analyses to reflective displays. Two important factors—cell gap control and device operation temperature—which greatly influence the display performance of film-compensated homogeneous cells are discussed in §5.

## 2. Compensation principles

The experimental configuration of the film-compensated homogeneous cell is depicted in figure 1 for the transmissive display. The LC director ( $L_1$ ) is arranged at  $45^\circ$

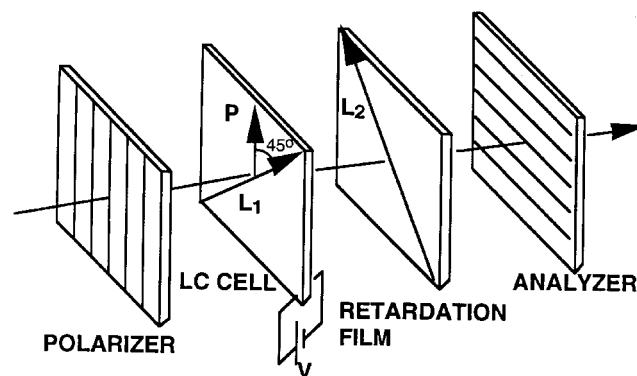

Figure 1. Device configuration of a film-compensated homogeneous LC cell. Note  $L_1$  = LC directors,  $L_2$  = axis of compensation film, and P = polarizer axis.

\* Author for correspondence.

with respect to the polarizer (P) in order to obtain maximum amplitude modulation. The axis ( $L_2$ ) of the uniaxial phase retardation film is oriented at  $90^\circ$  with respect to  $L_1$  so that their phase retardation is subtractive. In a transmissive display, the compensation film can be placed either before or after the LC cell and produce the same results. However, in a reflective display using only one polarizer, the film must be put between the polarizer and the LC cell in order to avoid parallax [10].

Under the crossed-polarizer condition, the light transmittance through a film-compensated homogeneous cell is described as  $T_{\perp} = \sin^2(\delta/2)$ . The net phase retardation  $\delta$  is expressed as:

$$\delta = 2\pi[d_1\Delta n_1(\lambda, V, T) - d_2\Delta n_2(\lambda, T)]/\lambda \quad (1)$$

where  $d_{1,2}$  and  $\Delta n_{1,2}$  represent the thickness and effective birefringence of the LC cell and compensation film, respectively. The effective birefringence of a LC depends on the wavelength ( $\lambda$ ), applied voltage ( $V$ ) and temperature ( $T$ ) [11]. The birefringence of a uniaxial polymeric film is mainly dependent on the wavelength and is not very sensitive to temperature [2].

From equation (1), it is essential to have a phase-retardation film with its birefringence dispersion similar to that of the LC mixture employed. Under such circumstances, nearly perfect compensation occurs for all the wavelengths used for colour display. Polycarbonate (PC) films possess excellent phase-matching to many low  $\Delta n$  LC mixtures owing to their similarity in molecular structures [2, 12]. Thus, throughout our computer simulations, we used polycarbonate as the compensation film and assumed perfect phase-matching.

### 3. Transmissive display

In the computer simulations, the LC director distributions and the corresponding electro-optic properties of the homogeneous cells were calculated by using Oseen-Frank elastic continuum theory and the extended Jones matrix method, respectively [11]. The LC parameters used in our computer simulations are listed as following:  $\varepsilon_{\perp} = 3.6$ ,  $\Delta\varepsilon = 5.0$ ,  $K_{11} = 15.8$ ,  $K_{22} = 6.0$ ,  $K_{33} = 17.9$  pN;  $\Delta n = 0.078, 0.080$ , and  $0.082$  for the three primary colours R = 650, G = 550 and B = 450 nm, respectively. The pre-tilt angle is assumed to be  $2^\circ$ . From equation (1), the LC layer thickness has a great impact on the light transmittance and operating voltage, and must be selected properly. To illustrate the design principles, we start with a transmissive display and choose a cell gap of  $d = 4.6 \mu\text{m}$  as an example. Under these conditions,  $d\Delta n$  is equal to  $0.368 \mu\text{m}$  at  $\lambda = 550$  nm.

#### 3.1. Electro-optic effect

The voltage-dependent light transmittance of the  $4.6 \mu\text{m}$  thick LC cell sandwiched between crossed

polarizers is shown in figure 2(a). In figure 2(a), we plot the normalized transmittance of the LC cell; the optical losses from the polarizers and the LC substrates are ignored. Without a compensation film, the light transmittance oscillates as the voltage is increased. No

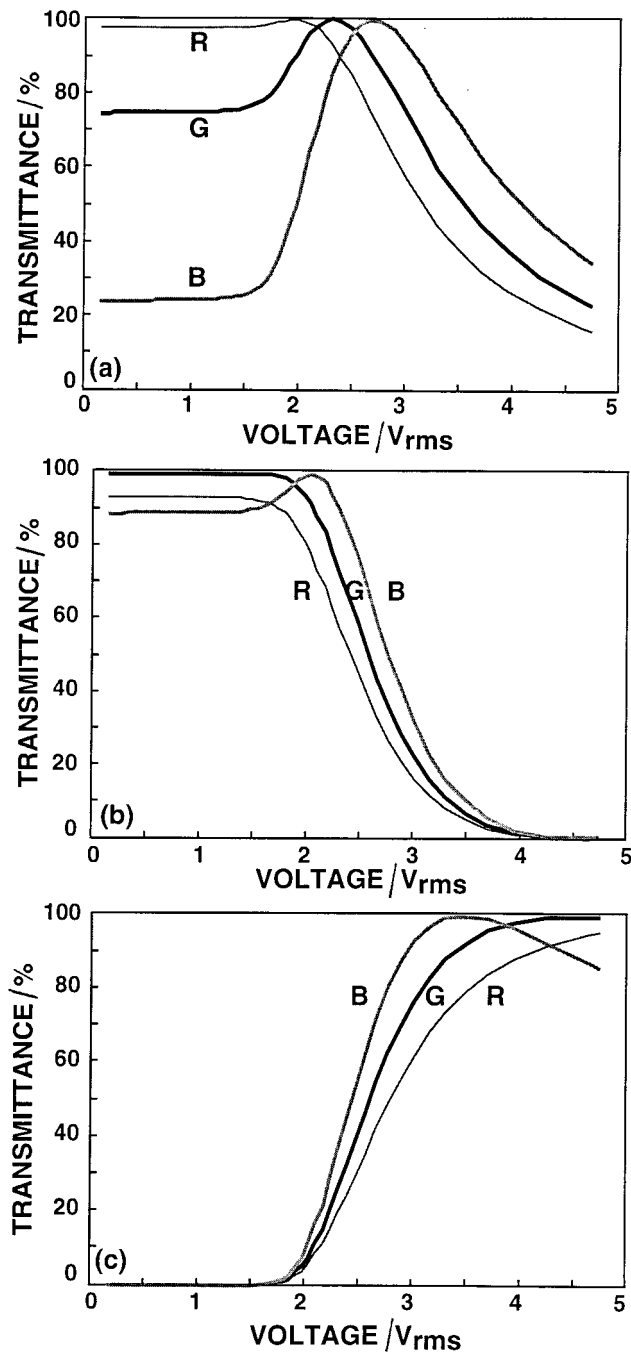

Figure 2. Computer simulation results on the voltage-dependent normalized transmittance of a  $4.6 \mu\text{m}$  LC cell: (a) With no compensation film, (b) with a polycarbonate film of  $d_2\Delta n_2 = 0.096 \mu\text{m}$  and (c) with a polycarbonate film of  $d_2\Delta n_2 = 0.368 \mu\text{m}$ . R = 650, G = 550 and B = 450 nm.

common dark state for the RGB wavelengths is obtained except at a very high voltage where virtually all the LC directors are aligned along the electric field direction. This voltage is too high to be practically reached by silicon-based thin-film-transistors. To reduce the dark-state voltage, we add a phase compensation film to cancel the phase retardation induced by boundary LC layers.

To select a proper  $d_2\Delta n_2$  of a uniaxial polycarbonate compensation film, we need to know the desired dark-state voltage beforehand. For example, if the dark-state is to occur at  $4.5 V_{\text{rms}}$ , we simply calculate the phase retardation of the LC cell at  $4.5 V_{\text{rms}}$  from figure 2(a) and choose a uniaxial film with the same amount of phase retardation. Based on such an exercise, we find the required  $d_2\Delta n_2$  is  $0.096\mu\text{m}$  at  $\lambda=550\text{nm}$ . At this wavelength, the birefringence of the polycarbonate film [2] is about  $0.00175$ ; thus, the film thickness would be  $55\mu\text{m}$ . If we increase the  $d_2\Delta n_2$  of the film, the dark-state voltage would be gradually reduced. When  $d_2\Delta n_2$  is equal to  $d_1\Delta n_1$  of the LC cell, a perfect phase cancellation occurs at  $V=0$  and a normally black mode is achieved.

### 3.2. Normally white mode

The voltage-dependent light transmittance of PC film-compensated,  $4.6\mu\text{m}$  thick homogeneous LC cells is depicted in figures 2(b) and 2(c) for  $d_2\Delta n_2=0.096$  and  $0.368\mu\text{m}$ , respectively. Figure 2(b) shows that the off-state transmittance is not very sensitive to wavelength. As the voltage is increased to  $4.5 V_{\text{rms}}$ , a common dark state for RGB wavelengths occurs. The wavelength dispersions observed in figure 2(b) are nearly as good as in a  $90^\circ$ -twisted nematic cell [13] in the normally white mode, although the physical mechanisms involved are different. In the  $90^\circ$ -TN cell, the polarization rotation effect [14] dominates while in the homogeneous cell, the phase retardation effect is the responsible mechanism.

The eight grey level viewing characteristics of such a normally white operation mode are calculated; results are shown in figures 3(a) and 3(b) for the horizontal and vertical viewing angles, respectively. Here we define the horizontal view as looking at the display along the principal axis of the polarizer which is at  $45^\circ$  to the LC directors. From figure 3(a), the horizontal viewing angle is about  $\pm 40^\circ$ . Beyond this range, reversed contrast occurs at the dark (voltage-on) state. The vertical view angle as shown in figure 3(b) is much narrower and light leakage is rather severe when viewing from the top-bottom direction at large oblique angles. Thus, this normally white transmissive mode is not suitable for direct-view or projection displays. For projection displays, the LC cell should possess a high contrast ratio within  $\pm 10^\circ$  of acceptance angle.

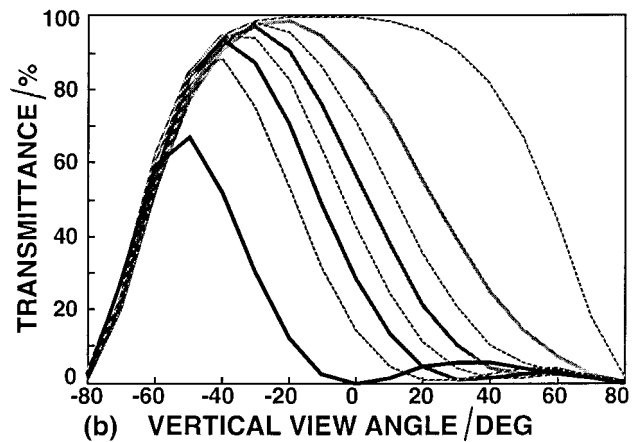
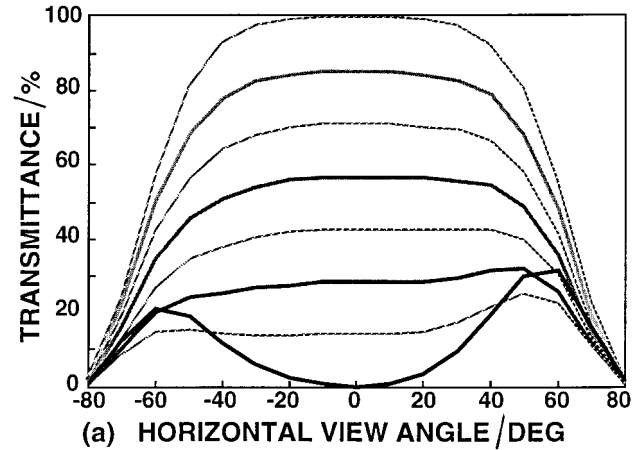

Figure 3. Calculated horizontal (a) and vertical (b) viewing angle of a PC film-compensated transmissive LC cell. The LC has  $d_1\Delta n_1=0.368\mu\text{m}$  and the PC film had  $d_2\Delta n_2=0.096\mu\text{m}$ .

### 3.3. Normally black mode

With increasing  $d_2\Delta n_2$  value, the dark state gradually shifts towards a lower voltage regime. When  $d_2\Delta n_2=d_1\Delta n_1$ , the phase retardation of the polycarbonate film cancels perfectly with the LC cell at  $V=0$  for all the wavelengths employed, as shown in figure 2(c). Increasing the applied voltage would turn the net phase retardation ( $\delta$ ) to negative. However, the normalized light transmittance is equal to  $\sin^2(\delta/2)$ . Thus, the display appears as normally black.

The eight grey level viewing characteristics of such a normally black display are calculated. Results are shown in figures 4(a) and 4(b) for the horizontal and vertical viewing angles, respectively. From figure 4, this normally black mode exhibits a wider horizontal viewing angle and lower dark-state leakage than the normally white mode. However, the reversed contrast still exists at beyond  $-20^\circ$  in the vertical viewing direction. Thus, such

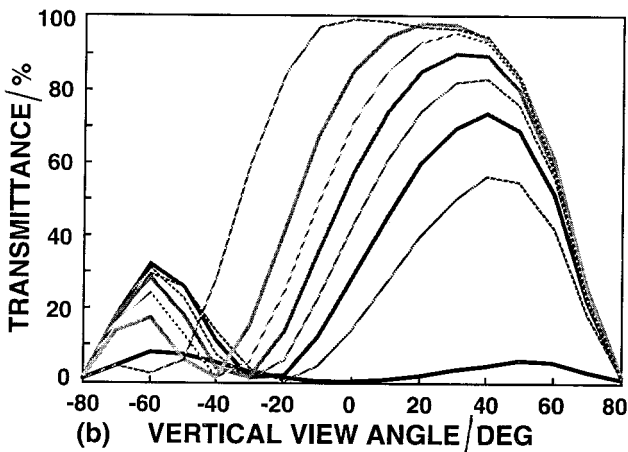
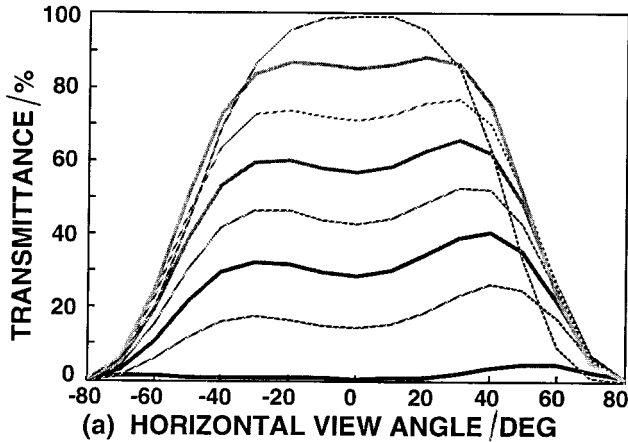

Figure 4. Calculated horizontal (a) and vertical (b) viewing angle of a PC film-compensated transmissive LC cell. The LC has  $d_1\Delta n_1 = 0.368 \mu\text{m}$  and the PC film has  $d_2\Delta n_2 = 0.368 \mu\text{m}$ .

a normally black mode barely meets the requirements for projection displays. Its viewing angle is still too narrow for direct-view displays.

#### 4. Reflective display

In a reflective display, owing to the double pass of the incident light, the required  $d\Delta n$  of the LC cell and film is reduced by a factor of two as compared with its corresponding transmissive display. As a result, the reflective display would exhibit a four-times faster response than a transmissive one. With the two-domain effect, the viewing angle is widened considerably. In the reflective direct-view display using only one polarizer, a quarter-wave film must be added between the polarizer and the LC cell in order to achieve a crossed polarizer configuration [10]; the reflector needs to be deposited inside the LC cell to avoid parallax.

#### 4.1. Electro-optic effect

The voltage-dependent light reflectance of a  $2.3 \mu\text{m}$  thick, reflective LC cell is identical to that shown in figure 2(a), except read *reflectance* instead of *transmittance*. Adding a PC film with  $d_2\Delta n_2 = 0.048$  and  $0.184 \mu\text{m}$ , the normalized reflectance curves are identical to those shown in figures 2(b) and 2(c) for the normally white and normally black displays, respectively.

#### 4.2. Normally white mode

The horizontal and vertical viewing angles of a normally white reflective display are shown in figures 5(a) and 5(b), respectively. From figure 5, such a reflective display exhibits a good dark-state within a  $\pm 20^\circ$  viewing cone. Thus, it is useful for a high contrast projection display. From figure 5(a), the horizontal viewing angle of such a reflective cell is wider than  $\pm 60^\circ$ . However, the reversed contrast still exists beyond  $-35/+45^\circ$  in the vertical viewing direction, figure 5(b). For a palm-sized

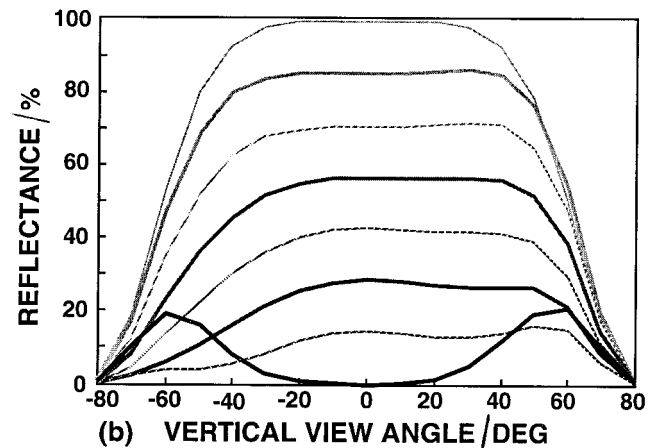
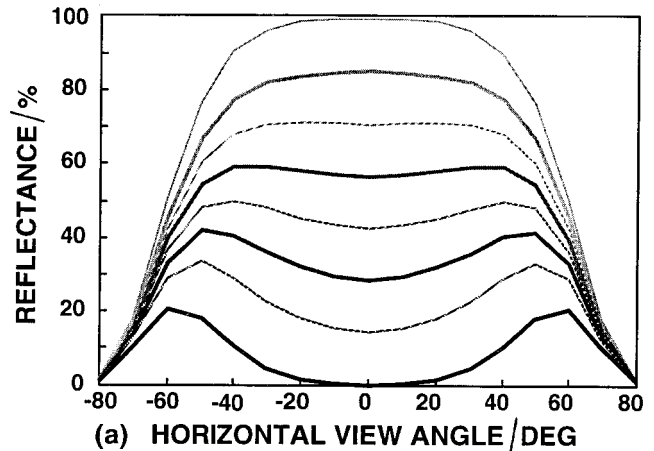

Figure 5. Calculated horizontal (a) and vertical (b) viewing angle of a PC film-compensated reflective LC cell. The LC has  $d_1\Delta n_1 = 0.184 \mu\text{m}$  and the PC film has  $d_2\Delta n_2 = 0.048 \mu\text{m}$ .

reflective display (e.g. personal digital assistance or hand-held personal computer), such a viewing range is marginal. Thus, this normally white reflective mode has potential for both projection and direct-view displays.

The dark-state shown in figure 5 corresponds to  $V = 4.5 V_{\text{rms}}$ . At this voltage, the central part of the LC directors are aligned almost perpendicular to the substrates, as in a homeotropic cell. In the small angle approximation, the effective phase retardation of a homeotropic cell is proportional to the square of the viewing angle [15]. The addition of a negative birefringence film could cancel the phase retardation at oblique angles and improve the viewing cone to  $60^\circ$ . An even wider viewing angle has been demonstrated by using two-domain and two compensation films [16].

To reduce the dark-state reflectance as observed in figure 5(b), we add a negative birefringence ( $n_x = n_y > n_z$ ) film with  $d(n_z - n_x) = -0.1 \mu\text{m}$ . Due to the isotropic refractive indices on the film surface ( $xy$  plane), the voltage-dependent reflectance at normal angle is the same as that shown in figure 2(b). The calculated horizontal and vertical viewing angles of such a negative and positive films-compensated homogeneous cell are shown in figures 6(a) and 6(b), respectively. From figure 6(a), the dark-state leakage is reduced significantly and the horizontal viewing angle exceeds  $\pm 70^\circ$ . From figure 6(b), a good dark-state is also obtained at a very wide vertical viewing range. The only drawback is that the eighth grey level (at  $V = 0$ ) shows reversed contrast with the seventh outside the  $30^\circ$  viewing angle. Since both eighth and seventh grey levels are all bright, this reversed contrast will not be so noticeable as the dark-state inversion depicted in figure 5(b).

For practical applications, the positive and negative films employed can be combined to form a biaxial film. The biaxial film has been used to widen the viewing angle of the optical-compensated-bend (OCB) cell [5, 6]. An inconvenience of the OCB cell is that it requires a constant bias voltage ( $\sim 2 \text{ V}$ ) in order to avoid domain instability. The homogeneous cell does not have such a problem. From figure 6, the biaxial film-compensated reflective homogeneous cell exhibits a normally white display with wide viewing angle and high contrast. Its application in both projection and direct-view displays is promising.

#### 4.3. Normally black mode

Using  $d_2 \Delta n_2 = 0.184 \mu\text{m}$ , a normally black display is obtained, identical to that shown in figure 2(c). The eighth grey level viewing characteristics of such a normally black reflective display have been calculated; results are shown in figures 7(a) and 7(b) for the horizontal and vertical viewing angles, respectively. From figure 7(a), the horizontal viewing angle is wider than

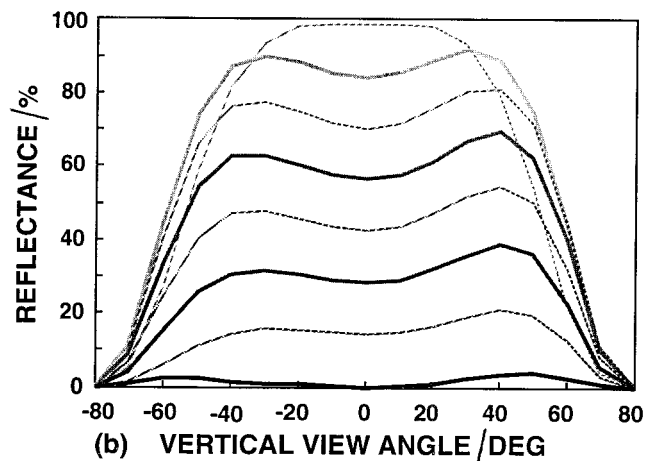
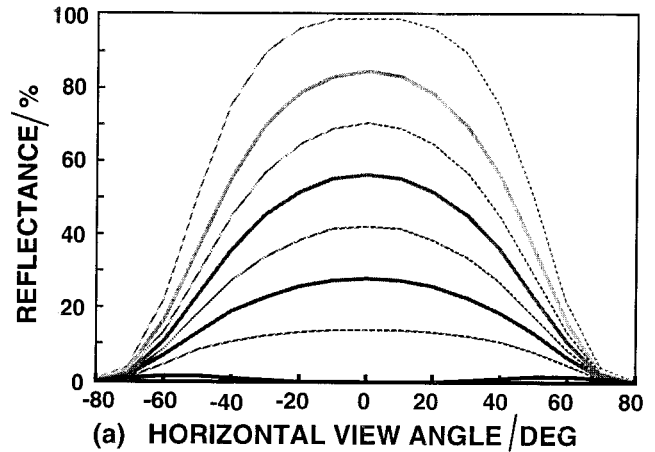

Figure 6. Calculated horizontal (a) and vertical (b) viewing angle of the LC system shown in figure 5 plus a negative birefringence film of  $d(n_z - n_x) = -0.1 \mu\text{m}$ .

$\pm 60^\circ$  and the dark-state reflectance remains quite low. This implies that a high contrast ratio within the indicated viewing range can be achieved. For the vertical view, the dark state (at  $V = 0$ ) reflectance is asymmetric. Up to the seventh grey level, the viewing angle remains wider than  $\pm 40^\circ$  without contrast inversion. However, the eighth grey level shows reversed contrast with the seventh at about  $\pm 25^\circ$ . This eighth grey level corresponds to  $V = 4.5 V_{\text{rms}}$ . At this voltage, the central parts of the LC directors are aligned almost perpendicular to the substrates, similarly to a homeotropic cell.

Similar to the approach mentioned above, we add a negative birefringence film with  $d(n_z - n_x) = -0.15 \mu\text{m}$ . The calculated horizontal and vertical viewing angles of such a negative and positive film-compensated homogeneous cell are shown in figures 8(a) and 8(b), respectively. From figure 8(a), the horizontal viewing angle remains wider than  $\pm 60^\circ$ , although its dark-state leakage is worse than that shown in figure 7(a). A major

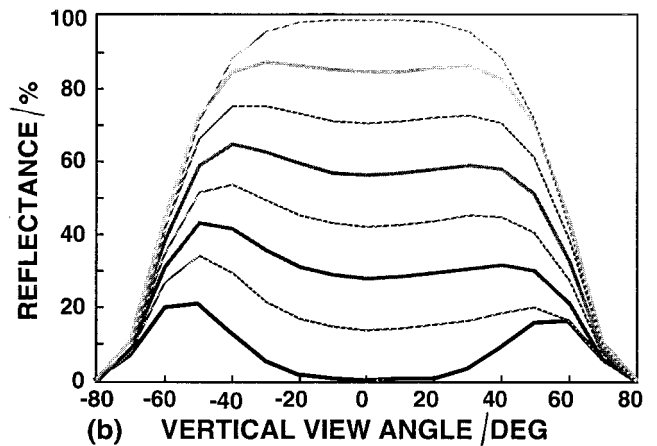
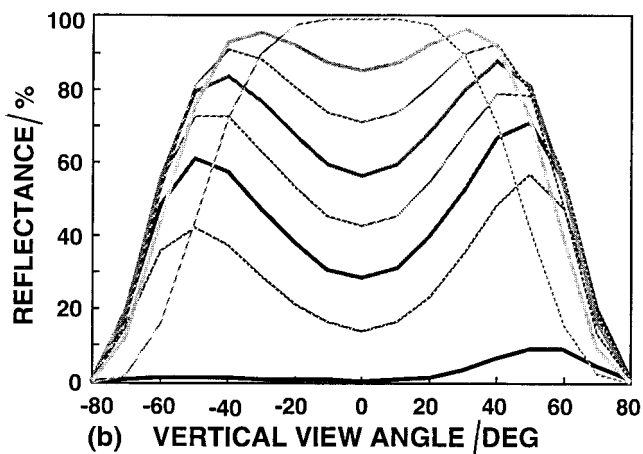
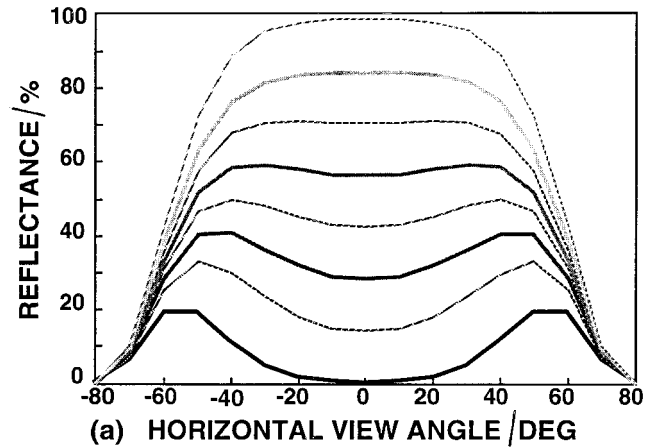
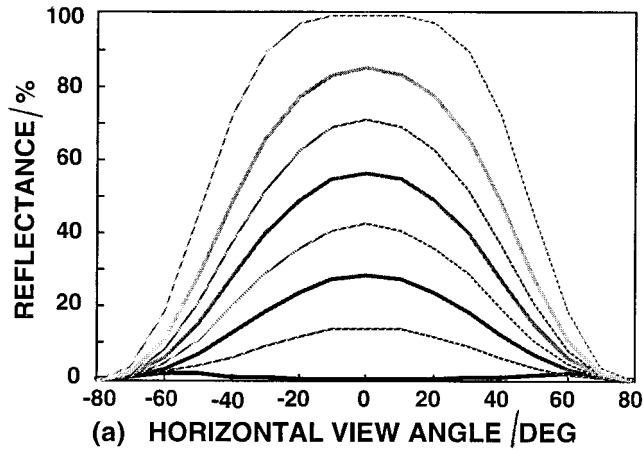

Figure 7. Calculated horizontal (a) and vertical (b) viewing angle of a PC film-compensated reflective LC cell. The LC has  $d_1\Delta n_1 = 0.184 \mu\text{m}$  and the PC film has  $d_2\Delta n_2 = 0.184 \mu\text{m}$ .

Figure 8. Calculated horizontal (a) and vertical (b) viewing angle of the LC system shown in figure 7 plus a negative birefringence film of  $d(n_z - n_x) = -0.15 \mu\text{m}$ .

improvement is observed in figure 8(b) where the eighth and seventh grey scale inversion is pushed to beyond  $\pm 50^\circ$ . Again, the positive and negative uniaxial films can be replaced by a biaxial film.

## 5. Discussion

The dark-state of a film-compensated homogeneous cell is greatly affected by the cell gap control and temperature fluctuation such as occur in a projection system. Temperature change affects device performance through changes in  $\Delta n$ . The cell gap and temperature effects can be combined and described as the  $d\Delta n$  effect. In this section, we shall discuss the  $d\Delta n$  effect on the normally white and normally black reflective displays.

### 5.1. Normally white display

In the normally white reflective display, the LC we used has  $d_1\Delta n_1 = 0.184 \mu\text{m}$  and the polycarbonate film

has  $d_2\Delta n_2 = 0.048 \mu\text{m}$ . We keep  $d_2\Delta n_2$  unchanged and investigate how the variation of  $d_1\Delta n_1$  affects display performance. Figures 9(a) and 9(b) show the voltage-dependent reflectance of a cell with  $d\Delta n$  deviated  $\pm 10\%$  ( $d\Delta n = 0.2$  and  $0.16 \mu\text{m}$ , respectively) from its optimal value. As shown in figures 9(a) and 9(b), a 10%  $d\Delta n$  variation causes a noticeable reflectance change in the RGB wavelengths and a modest shift in the dark-state voltage. Both effects can be explained directly from the phase retardation change of the LC cell. If the  $\Delta n$  of a LC remains constant, then a 10% decrease in cell gap [figure 9(b)] would cause an  $\sim 10\%$  reflectance change for the green wavelength and  $\sim 0.4 \text{ V}$  decrease in the dark-state voltage.

Next, we estimate how many degrees of temperature change would lead to a 10% change in  $\Delta n$ , assuming the cell gap is kept unchanged. To do so, let us use Haller's empirical formula for temperature dependent

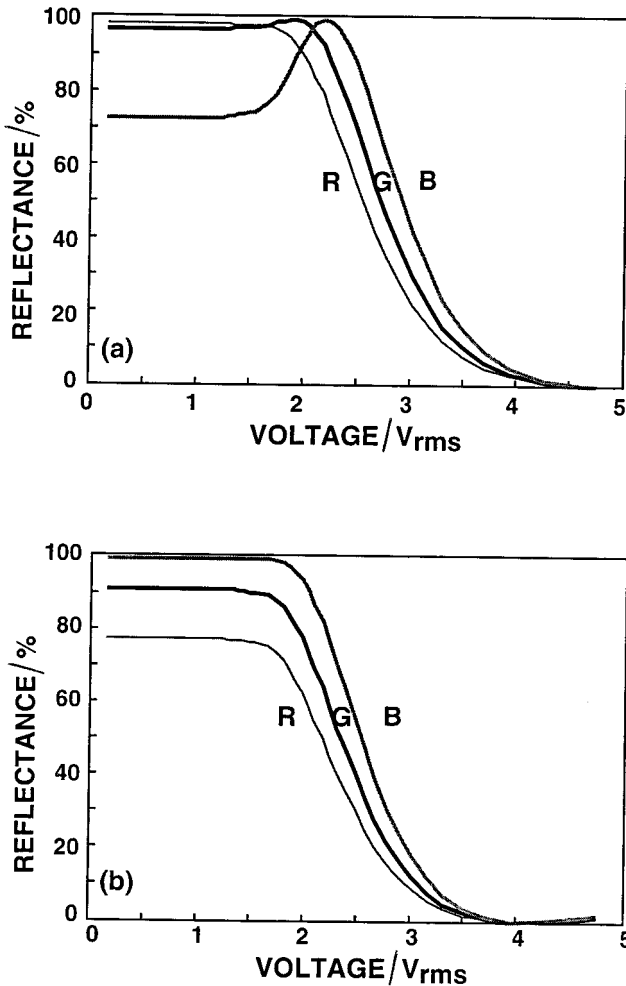

Figure 9. Cell gap effect on the voltage-dependent reflectance of a normally white film-compensated homogeneous cell: (a)  $d = 2.5 \mu\text{m}$ , (b)  $d = 2 \mu\text{m}$ . The LC has  $\Delta n = 0.08$  and the PC film has  $d_2 \Delta n_2 = 0.048 \mu\text{m}$ .

birefringence [17]:

$$\Delta n = \Delta n_0 (1 - T/T_c)^\beta \quad (2)$$

where  $\Delta n_0$  stands for the birefringence at  $T = 0$ ,  $T_c$  is the clearing point of the LC mixture and  $\beta$  is a material parameter. Let us assume the LC mixture has  $T_c \sim 360 \text{ K}$  and  $\beta \sim 0.2$ . We find, when the LC cell is heated to  $48.6^\circ\text{C}$ , that its  $\Delta n$  drops by 10% from that for  $T = 22^\circ\text{C}$ . Therefore, when we design a LC cell for projection display, its actual operation temperature has to be taken into consideration in order to optimize the display performance.

### 5.2. Normally black display

In the normally black reflective display, the LC and film we used represent an ideal condition with  $d_1 \Delta n_1 = d_2 \Delta n_2 = 0.184 \mu\text{m}$ . This condition may not be easily satisfied due to cell gap uncertainty during fabrication

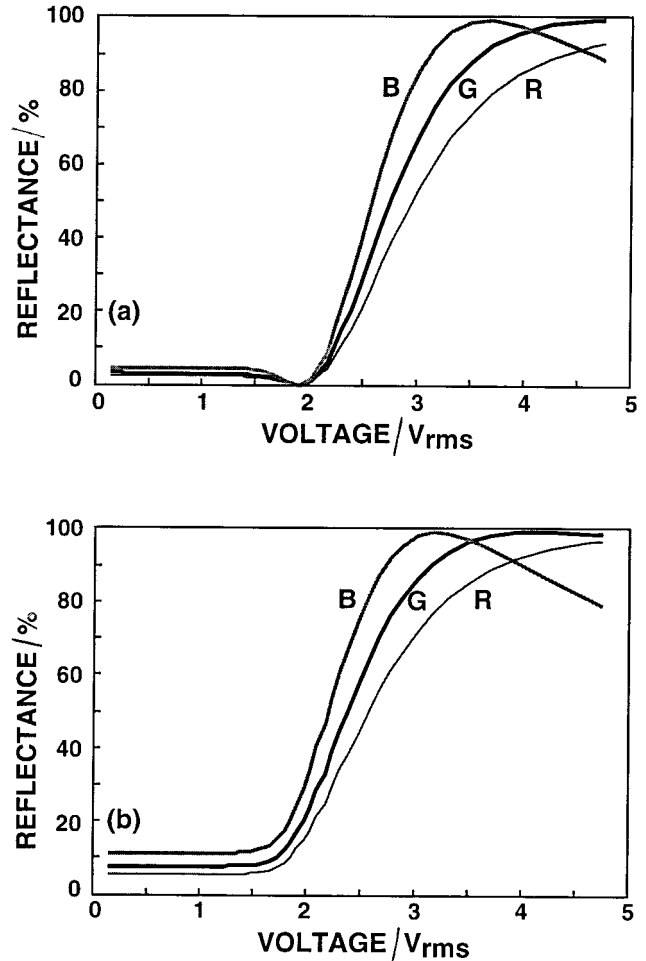

Figure 10. Cell gap effect on the voltage-dependent reflectance of a normally black film-compensated homogeneous cell: (a)  $d = 2.5 \mu\text{m}$ , (b)  $d = 2 \mu\text{m}$ . The LC has  $\Delta n = 0.08$  and the PC film has  $d_2 \Delta n_2 = 0.184 \mu\text{m}$ .

processes and temperature change. Figures 10(a) and 10(b) depict the voltage-dependent reflectance curves for cells with  $d_1 \Delta n_1 = 0.2$  and  $0.16 \mu\text{m}$ , respectively. For a cell with its  $d_1 \Delta n_1 \sim 10\%$  higher than  $0.184 \mu\text{m}$ , some light leakage is observed in the null voltage state, as shown in figure 10(a). Two methods can be used to boost the contrast: (1) to apply a  $1.9 V_{\text{rms}}$  bias voltage across the LC cell; (2) to increase the PC film's thickness by 10%. For the  $d_1 \Delta n_1 = 0.16 \mu\text{m}$  cell, the light leakage in the voltage-off state [figure 10(b)] is too high and contrast ratio has deteriorated dramatically. The only way to recover the contrast is to use a 10% thinner polycarbonate film.

Another simple method for compensating the cell gap variation is to use Merck's two or three-bottle LC mixture†. These mixtures enable the  $\Delta n$  value to be

† For example, the Merck two bottle mixture ZLI-4761-000/100 offers a tunable birefringence in the range from 0.086 to 0.097.



tuned quasi-continuously within a relatively wide range by adjusting the mixing ratio from each bottle. Besides  $\Delta n$ , the other physical properties of the mixture in each bottle, such as dielectric constant, elastic constant and phase transition temperature are kept as similar as possible.

The major advantage of using a thin LC cell is its short response time. In the  $d\Delta n = 0.184 \mu\text{m}$  reflective cell, if  $\Delta n = 0.08$ , then  $d = 2.3 \mu\text{m}$ . The response time of such a thin cell is less than 5 ms. Colour sequential projection display using a film-compensated homogeneous cell would be technically feasible. On the other hand, for the interest of easy cell gap control, we may use a lower  $\Delta n$  LC; e.g. if  $\Delta n = 0.05$ , then  $d \sim 3.7 \mu\text{m}$ . Such a cell gap is not too difficult to fabricate.

### 6. Conclusion

Reflective-type, biaxial film-compensated homogeneous LC cells exhibit a small wavelength dispersion, wide viewing angle, high contrast and fast response time so that they are promising candidates for both projection and direct-view displays. The normally white reflective display possesses a larger  $d\Delta n$  tolerance than the normally black mode. To overcome possible cell gap variation and thus improve manufacturing yield, multiple bottle LC mixtures with adjustable birefringence may be considered.

The authors are indebted to AFOSR for financial support under Contract No. F49620-94-C-0078.

### References

- [1] WU, S. T., 1993, *J. Appl. Phys.*, **73**, 2080.
- [2] WU, S. T., and LACKNER, A. M., 1994, *Appl. Phys. Lett.*, **64**, 2047; WU, S. T., and LACKNER, A. M., 1994, *SID Int. Symp. Dig.*, **25**, 923.
- [3] POHL, L., WEBER, G., EIDENSCHINK, R., BAUR, G., and FEHRENBACH, W., 1981, *Appl. Phys. Lett.*, **38**, 497.
- [4] SCHADT, M., and GERBER, P. R., 1981, *SID Int. Symp. Dig.*, **12**, 80.
- [5] MIYASHITA, T., VETTER, P., SUZUKI, M., YAMAGUCHI, Y., and UCHIDA, T., 1993, in Proceedings of the 13th International Display Research Conference, 31 August, 1993 (Strasbourg), p. 149.
- [6] KUO, C. L., MIYASHITA, T., SUZUKI, M., and UCHIDA, T., 1994, *SID Int. Symp. Dig.*, **25**, 927.
- [7] KUO, C. L., WEI, C. K., WU, S. T., and WU, C. S., 1997, *Jpn. J. appl. Phys. I*, **36**, 1077.
- [8] YANG, K. H., 1991, in Proceedings of the International Display Research Conference, 15–17 October, 1991, San Diego, p. 68.
- [9] LU, K., and SALEH, B. E. A., 1996, *SID Int. Symp. Dig.*, **27**, 63.
- [10] WU, S. T., and WU, C. S., 1996, *Appl. Phys. Lett.*, **68**, 1455.
- [11] KHOO, I. C., and WU, S. T., 1993, *Optics and Nonlinear Optics of Liquid Crystals* (Singapore: World Scientific).
- [12] FUJIMURA, Y., NAGATSUKA, T., YOSHIMI, H., and SHIMOMURA, T., 1991, *SID Int. Symp. Dig.*, **22**, 739.
- [13] SCHADT, M., and HELFRICH, W., 1971, *Appl. Phys. Lett.*, **18**, 127.
- [14] GOOCH, C. H., and TARRY, H. A., 1975, *J. Phys. D*, **8**, 1575.
- [15] WU, S. T., 1994, *J. appl. Phys.*, **76**, 5975; WU, S. T., 1995, *SID Int. Symp. Dig.*, **26**, 555.
- [16] OHMURO, K., KATAOKA, S., SASAKI, T., and KOIKE, Y., 1997, *SID Int. Symp. Dig.*, **28**, 845.
- [17] HALLER, I., 1975, *Prog. Solid State Chem.*, **10**, 103.